

HAWORTH CASTINGS

PART OF EXPROMET TECHNOLOGIES GROUP

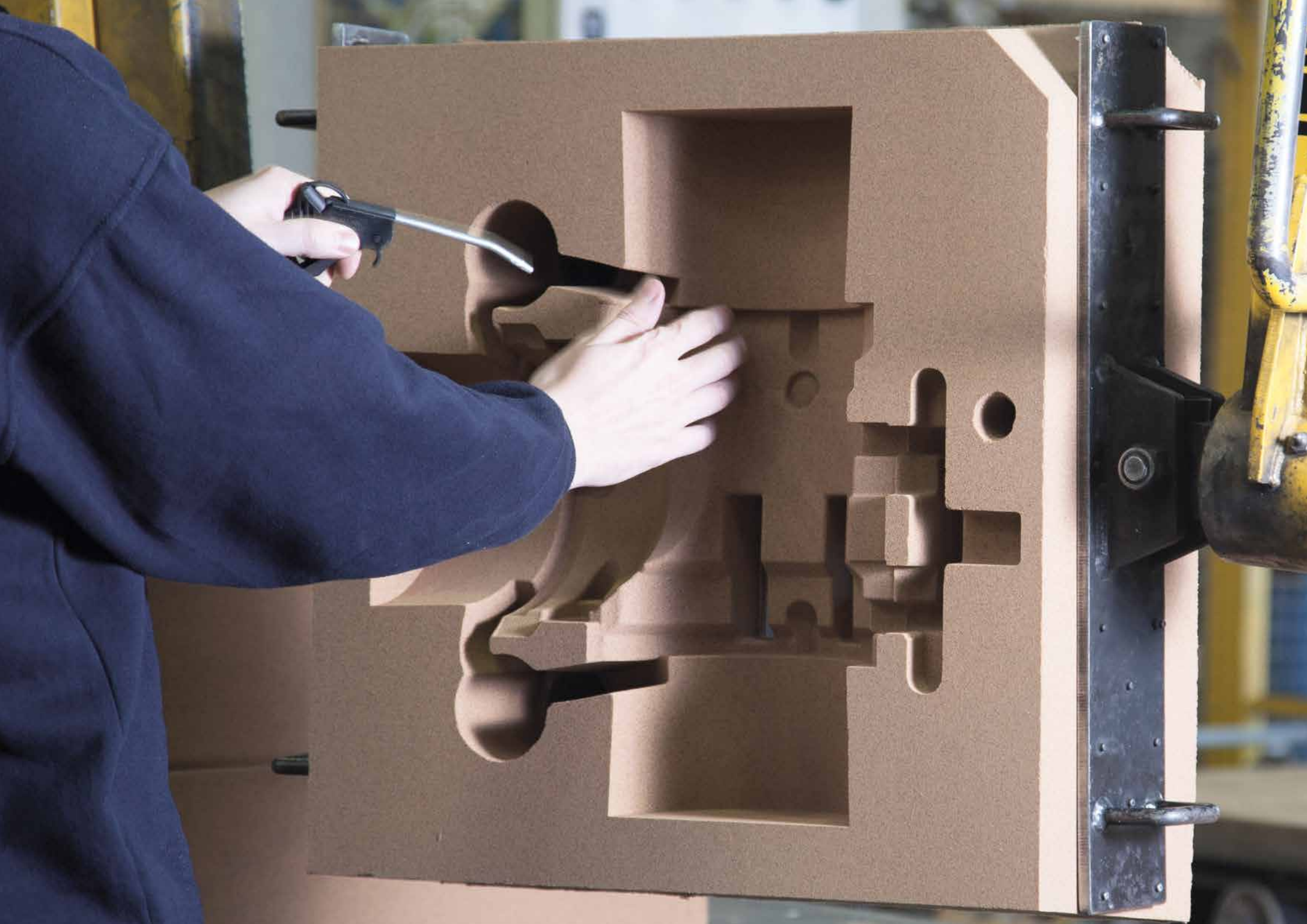

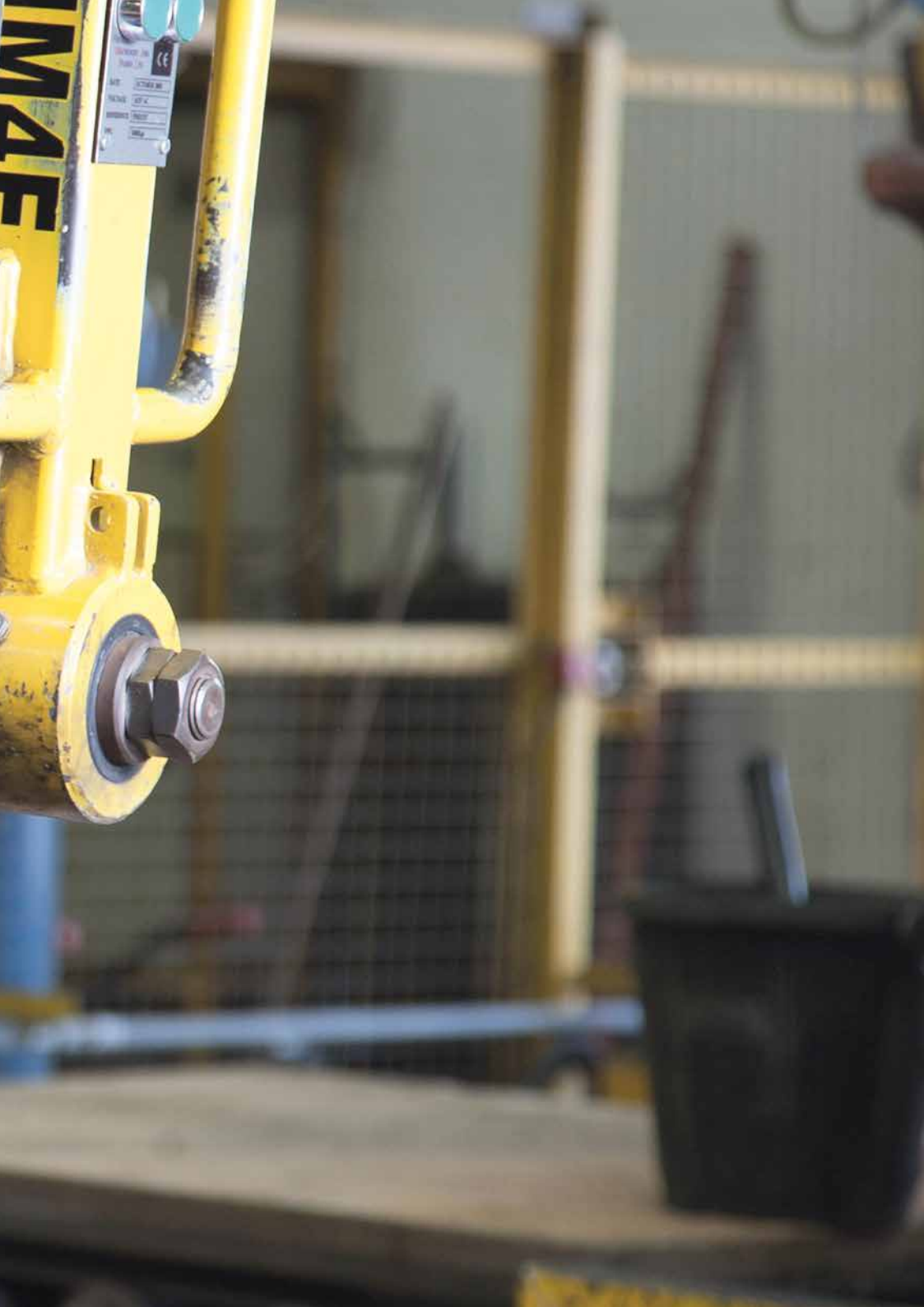

Our History

60 years' experience and knowledge.

We specialise in producing high integrity cast and machined components for a wide range of industries. We provide a fully managed service from initial design phase to final production.

Through an ongoing programme of investment Haworth Castings are at the forefront of casting technology. We take pride in our ability to resolve the most complex technical challenges.

In 2017, Haworth Castings became part of Expromet Technologies Group, a privately-owned foundry group that also owns Investacast, a leading investment casting business, and Metaltech Precision, a leading manufacturer of CNC machined components. Expromet harnesses the capabilities of a group of complementary advanced precision casting and machining businesses to deliver world class engineering solutions to customers on a global basis.

[Single Point Sourcing]

- Complete project management
- Pre-production sampling
- Finishing and post processing
- Testing and quality assurance

Our Approach

Providing solutions to complex casting challenges.

Haworth Castings offer a complete solution encompassing casting, machining and post processing.

We pride ourselves in resolving the most demanding of casting requirements. In fact the more difficult and intricate, the more we enjoy the challenge. Our dedicated support team is here to help and advise through all stages of the process.

Utilising the very latest technology and drawing upon 60 years of experience, we will work closely with you to deliver the best casting for your needs.

“ We’ve worked closely with Haworth Castings since 2002, having previously tried at least 3 other castings suppliers. Their castings quality and consistency are simply second to none. But more than this they are easy to get on with and always happy to give input and advice. ”

- Mark Chapman, EPS Logistics Technology Ltd.

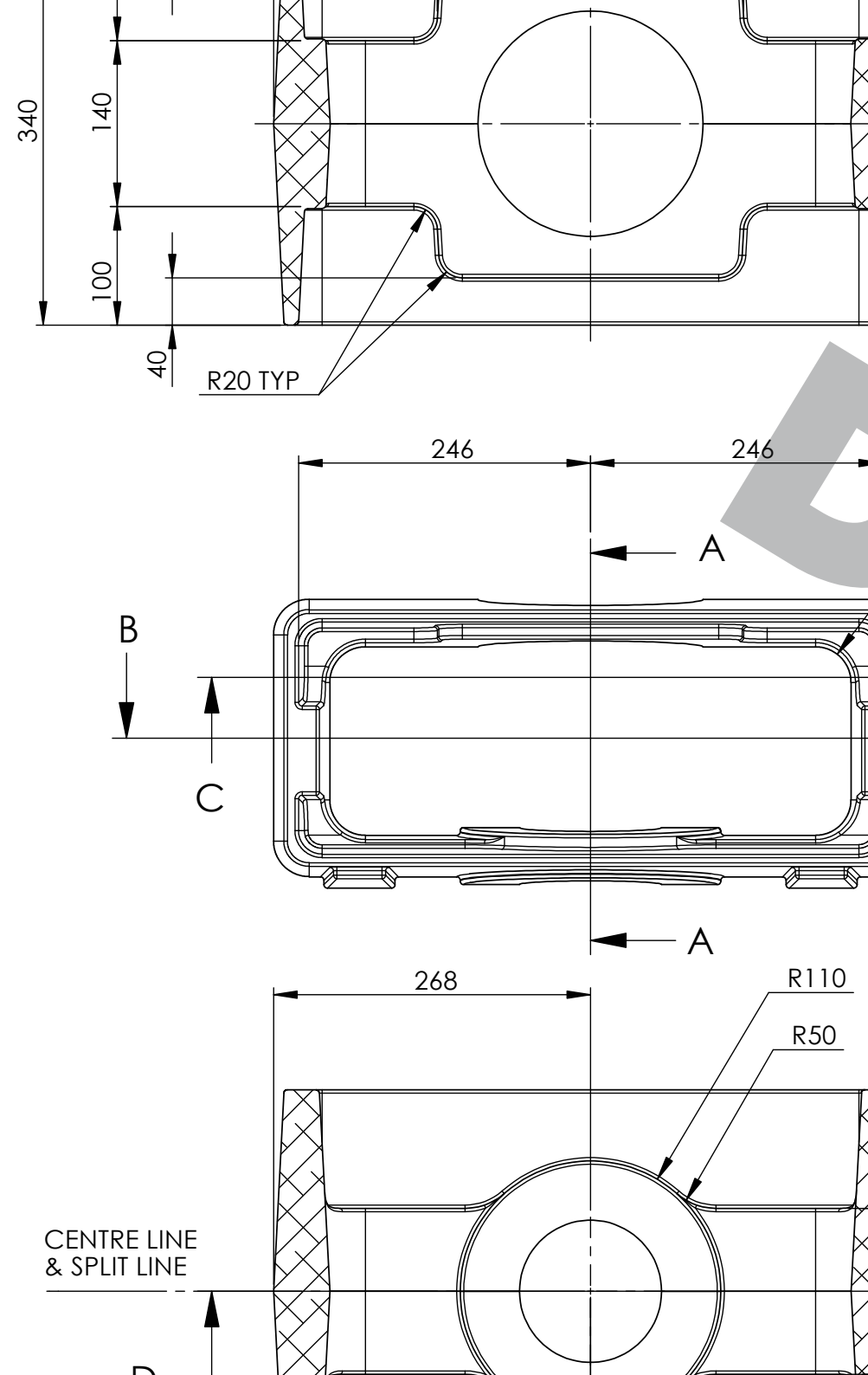

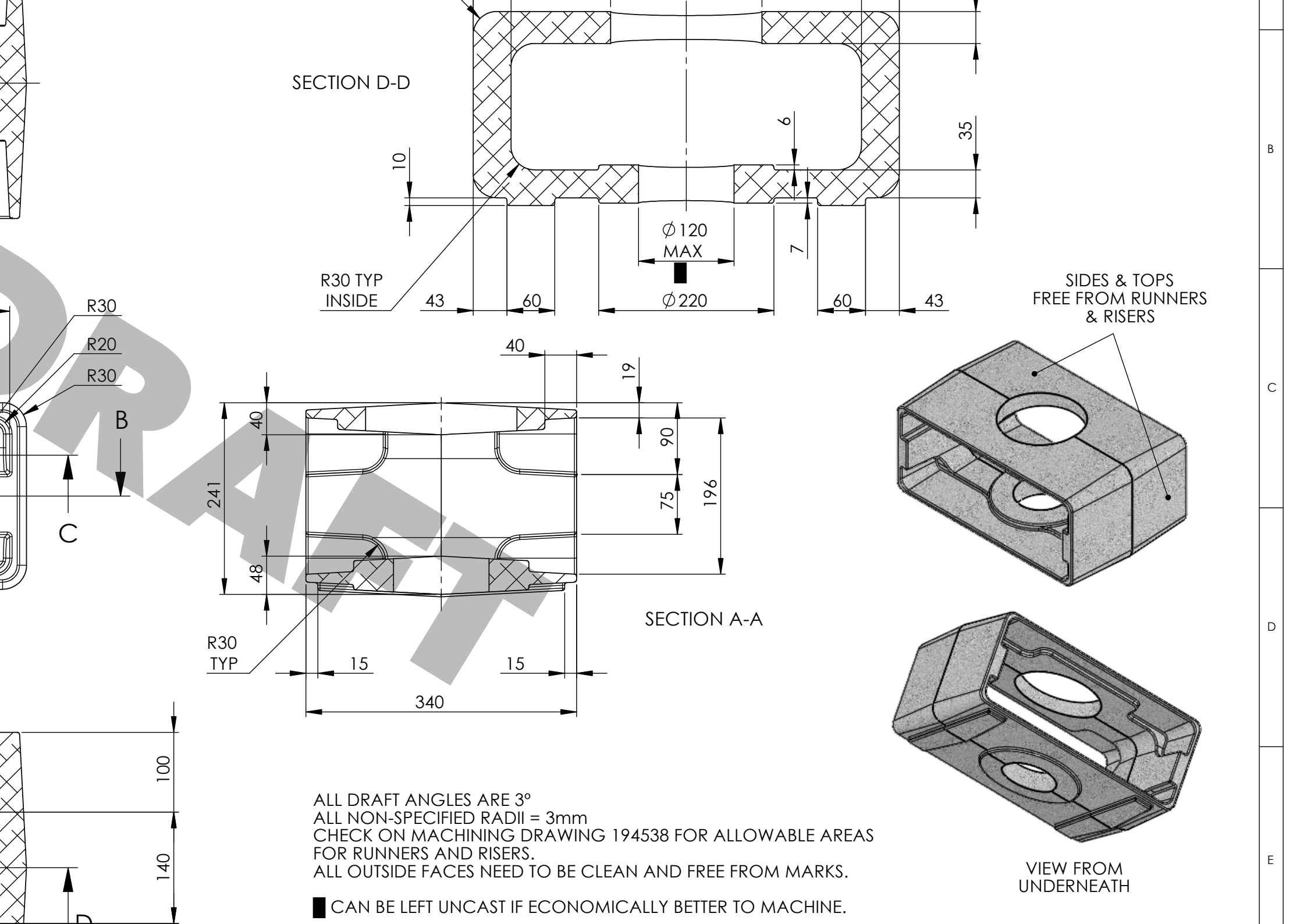

SECTION D-D

R30 TYP
INSIDE

Ø 120
MAX

Ø 220

SIDES & TOPS
FREE FROM RUNNERS
& RISERS

SECTION A-A

R30
TYP

VIEW FROM
UNDERNEATH

ALL DRAFT ANGLES ARE 3°
 ALL NON-SPECIFIED RADII = 3mm
 CHECK ON MACHINING DRAWING 194538 FOR ALLOWABLE AREAS
 FOR RUNNERS AND RISERS.
 ALL OUTSIDE FACES NEED TO BE CLEAN AND FREE FROM MARKS.
 ■ CAN BE LEFT UNCAST IF ECONOMICALLY BETTER TO MACHINE.

B
C
D
E

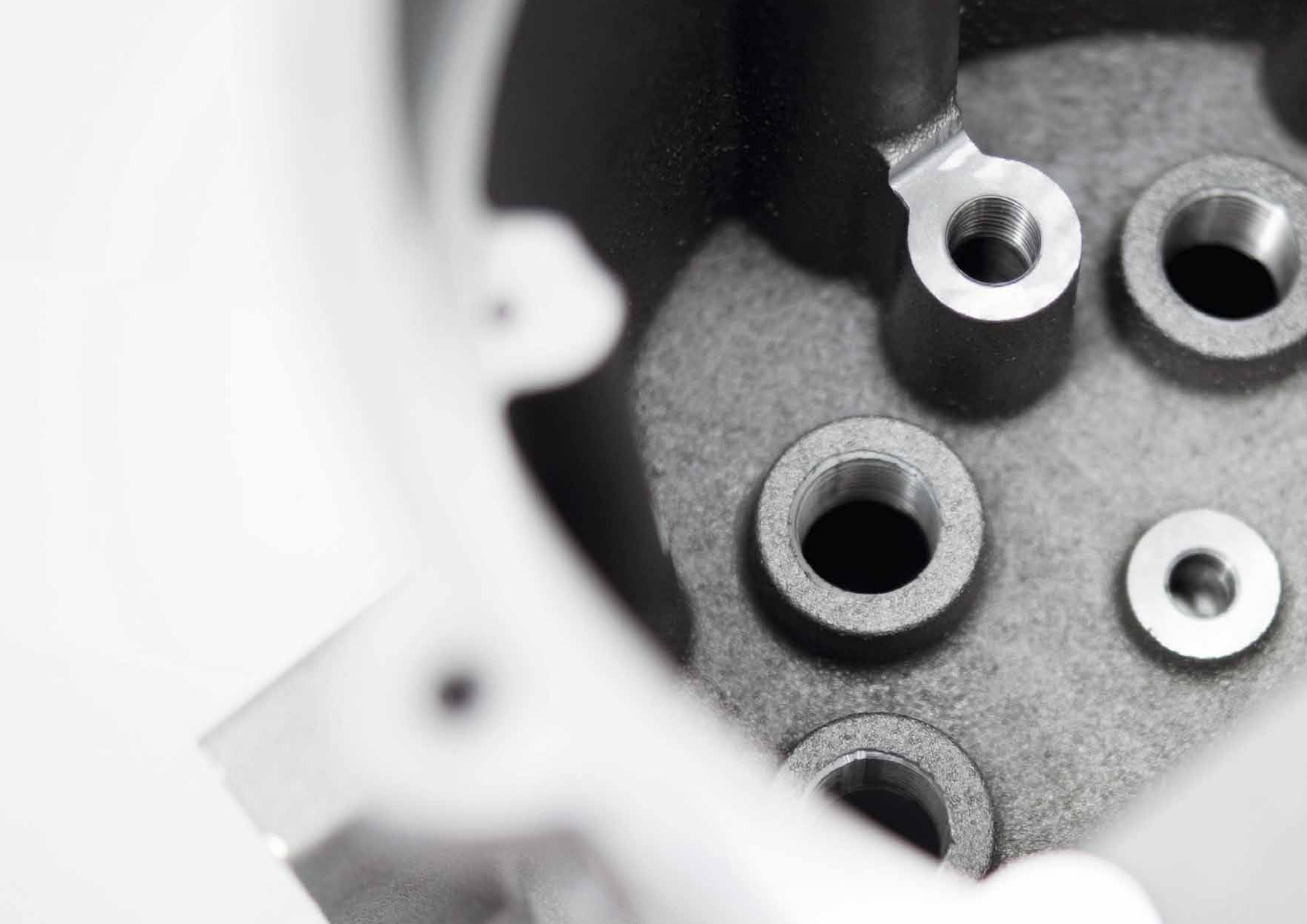

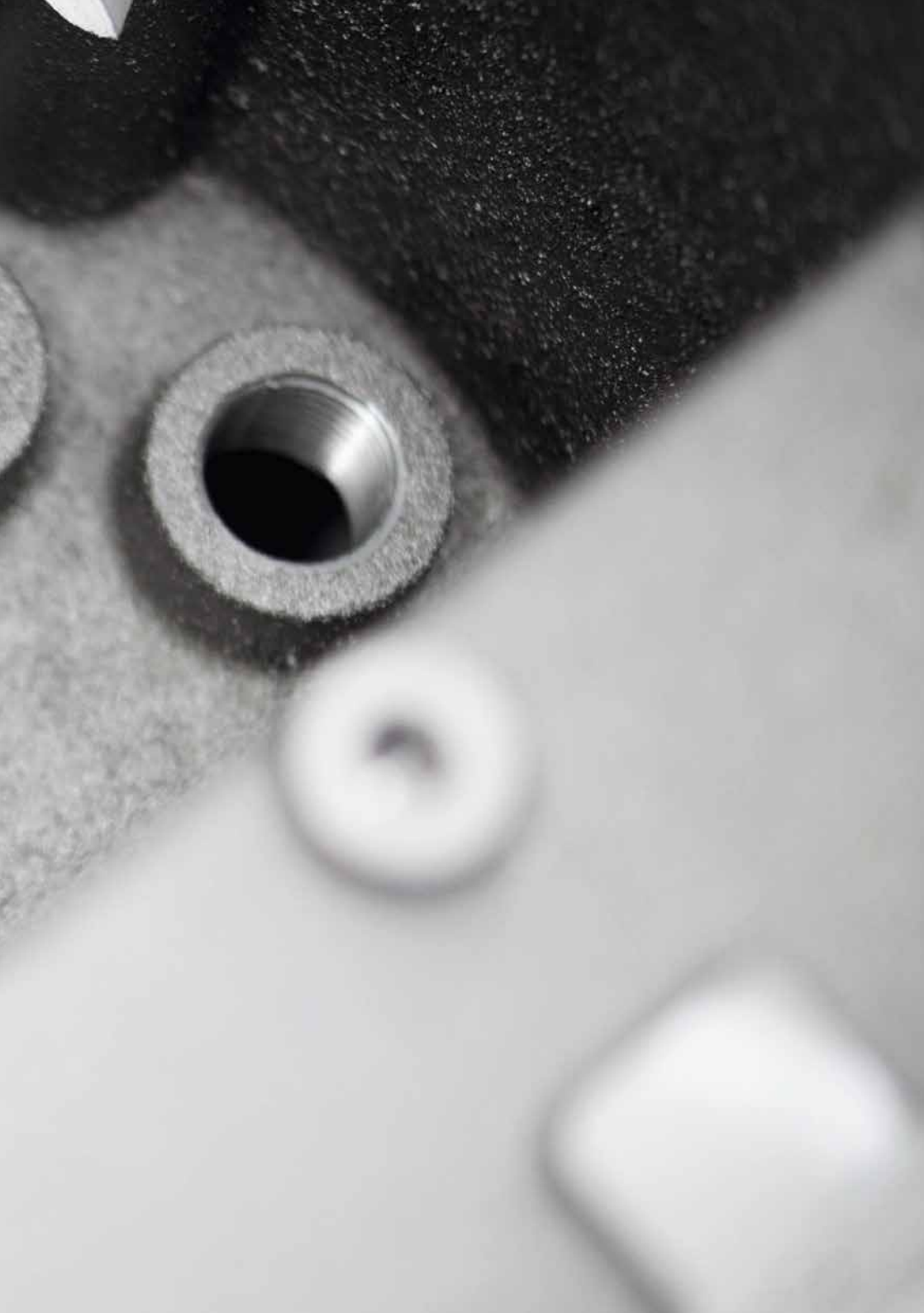

Quality Assurance

Dedicated to casting quality and integrity.

In our 60-year history, casting quality and integrity has always been our primary focus.

At Haworth Castings, the needs of our customers are clearly understood through close liaison at all stages.

With our dedicated technical support team looking after you, rest assured we will exceed your quality expectations.

We hold ISO 9001 approval for all our processes and quality controls. This provides our customers with confidence that we can surpass their exacting standards.

[ISO 9001 : 2015]



High Definition Sand Castings

High specification, tested and machined non-ferrous sand castings.

Haworth Castings, using 80 AFS sand, produce castings of exceptional definition. The sand we use in our process is 100% thermally recycled.

Fully framed patterns are used to produce the moulds. Depending on size, these moulds are either manually handled or removed from the frames automatically. This automatic process, for larger moulds, guarantees a smooth release generating a sharp impression. Ultimately, this gives the casting excellent definition.

We use three different types of cores in our foundry process which allows us to create elaborate internal cast features. Shell cores in particular, offer specific benefits for sand removal and accuracy.

[Alloys]

- Aluminium to BS EN 1706 (1998)
- Copper based to BS EN 1982 (1999)

Specialist and aerospace approved alloys are available.

Nominal Cast Weights

- Aluminium 500kgs
- Copper based 200kgs









Gravity Die Castings

Exceptional dimensional accuracy.

If you have a requirement for volumes approaching 500 units, then you should consider the gravity die route. Depending on the application this number could rise to in excess of 10,000 units using this process.

The maximum cast weight for gravity die is 40 kilos, and the die can incorporate steel, shell, or sand cores to create internal features.

Gravity dies are frequently used to manufacture intricately shaped components for a wide range of industrial applications. They provide a consistently high level of dimensional accuracy and form.

Gravity die castings deliver a cost-effective solution for medium volume requirements. Our wealth of knowledge and experience means we can offer extremely competitive solutions.

[Production Methods]

- Bench
- Mechanised
- Hydraulic
- Tilt pour

Capacity: 40kgs nominal

Finishing

Automated and manual techniques.

Cutting and finishing are the first two stages of the fettling process.

Cutting involves the removal of the runners, risers and any excess material from the casting. Finishing involves the rapid removal of excess material whilst grinding or sanding creates the correct casting profile.

Stainless steel shot blasting homogenises the prepared cast surface giving a uniform, clean, and aesthetically pleasing texture. The casting is placed in an enclosed blast cabinet and metal shot is propelled at the casting.

Rumbling is a gentler process that uses polished stones to produce a smoother, more tactile, surface.

[Finishing]

A range of automatic and manual finishing techniques are employed in the finishing process:

- Cutting
- Finishing
- Filing
- Shot blasting
- Rumbling





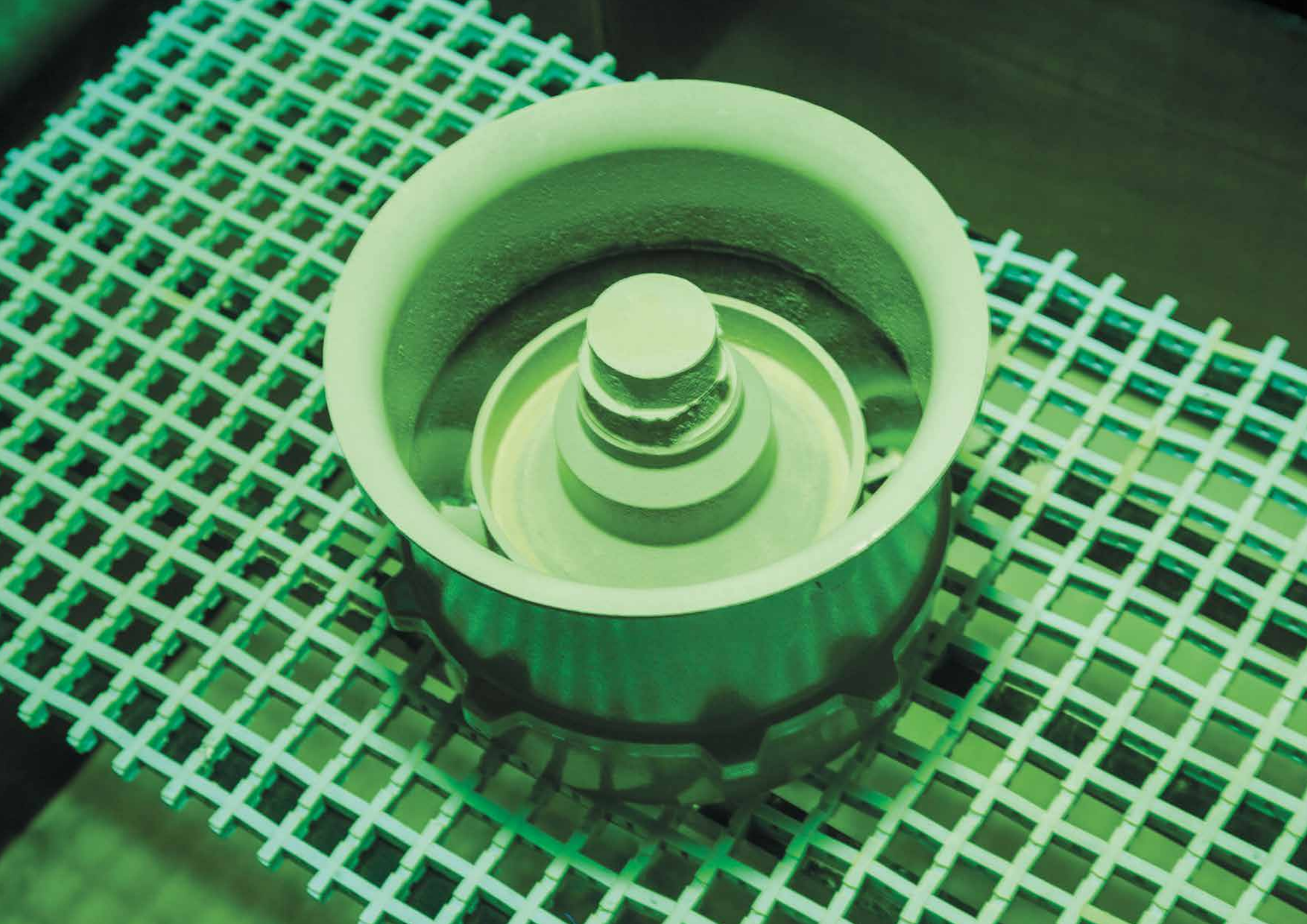

Non-Destructive Testing and Inspection

We offer a range of UKAS approved NDT testing and inspection services to meet the most demanding casting specifications. The three most commonly used are:

E155 Radiographic Inspection

Radiographic inspection is one of the most effective methods for detecting defects, such as porosity.

As part of the radiographic process, X-rays are projected toward the casting. Some of the X-rays are absorbed by the casting whilst others pass through and images are captured by digital detectors.

Inspection of the resulting images reveal whether the casting meets the acceptance criteria.

Penetrant Testing

This process can detect tiny cracks, pores or other surface discontinuities on a wide range of materials.

The castings are dipped into the penetrant, which is drawn into any discontinuity by capillary action. Inspection is then carried out under ultraviolet light and surface indications are interpreted to establish casting integrity.

This technique is more cost effective than radiography but has limitations as only surface flaws are detectable.

Chemical and Mechanical Testing

Often customers require actual values of the above properties to satisfy the product requirements. These are non-destructive tests but will ensure full compliance of the material.

Mechanical values for 0.2% proof stress, UTS and elongation are important where castings are in a safety critical environment or where factors of safety are a design requirement.

Chemical analysis, that meets international standards, affords these properties to be achieved.

Post Processing

We offer a range of treatments to strengthen and protect the castings, and meet specific customer requirements.

Heat Treatment

Heat treatment is used to improve the mechanical and physical properties of aluminium castings.

At Haworth Castings, we use various heat treatment conditions - water quenching, stress-relieving and polymer quenching.

Anodising and Alocroming

Alocroming is the process whereby the casting is coated in a chemical solution. Also known as chromating, this involves coating the casting in a chemical solution to form a protective film.

Painting

Aluminium castings can be finished with a range of painted finishes to meet client specifications.

The most common types of painted finishes are powder coating, wet spray, lacquer and enamelling.

Moly Spraying

Moly spraying is a process used to create wear resistant coatings on aluminium castings.







Machining

The complete range of machining services.

Haworth Castings has a purpose built, state-of-the-art machining facility, catering for both its own and sub-contracted requirements.

Machining is carried out by computer numerical control (CNC), with specialist 5-axis, multi-pallet machine centres programmed to guide the machining tools and shape the component accordingly.

As specialist machinists, we are experienced with a variety of materials including titanium, bronze, steels, plastics and resins as well as aluminium and copper.

[Machining]

We offer a complete range of machining services:

- 5-axis, multi-pallet machining centres
- Vertical machining
- Horizontal machining
- Turning, milling, grinding and drilling

Inspection

Precise CMM measurement.

At Haworth Castings, we thoroughly inspect our castings using Co-ordinate Measuring Machines (CMM) and specialist Bowers Gauges.

Wherever possible, CMM are our chosen method of measurement. These machines offer accuracy down to a few microns and give consistent repeatability.

Components are checked using a pre-written and approved CMM program. This ensures that the part is not only automatically checked in the same way each time, but that the results are confirmed against the pre-entered drawing specification - thus eliminating any chance of human error.

[Inspection]

Our castings are thoroughly inspected using the following machinery:

- Aberlink CMM machines
- Bowers Gauges
- Renishaw SP10 scanning machines
- Renishaw SP25 scanning heads





INSPECTION

Our Customers

Aerospace

Haworth Castings has been working in the aerospace sector since the company was founded.

As well as working on engine components, our remit also encompasses all aspects of aviation castings that include ground requirements, such as alignment fixtures, ground refuelling and metering.

Defence

After 30 years of manufacturing casting components for the defence industry, our expertise lies in producing high integrity components with stringent testing requirements.

With the capability to x-ray, crack detect, ultrasonically test and chemically and mechanically analyse, our clients can be satisfied that our castings are tested to UKAS accredited standards.

Energy

Haworth Castings has worked within the energy sector for over 20 years, with both large and small companies delivering their exacting requirements.

Castings in this sector range between 0.5 to 400kg, demonstrating the flexibility of the foundry. Our aluminium castings pass the highest scrutiny and we test to international and customers' bespoke standards.





Marine

Haworth Castings work with the marine industry producing specific bespoke and low volume aluminium and copper based castings.

Whilst the preferred method is fully framed patterns, we have the capability to use loose patterns meaning we can satisfy smaller demands whilst being very competitive on price.

Medical

Having worked in the medical sector for the past 30 years, Haworth Castings has developed a wide range of aluminium and copper based castings for various applications within this sector.

From general castings for operating theatre equipment to the more elaborate castings for scanners, we can provide components across the board.

Automotive

With over 15 years' experience in manufacturing automotive aluminium castings, Haworth Castings specialise in sampling, development and pre and main production.

Our experience means we can get sampling and production tooling developed extremely quickly, ideal when development timescales are short.

Sustainability

We recycle 100% of our sand.

Sustainability is embedded in the way we work. We appreciate that managing our impact on the environment delivers many environmental, quality and cost benefits.

We recycle 100% of our sand and many of our other raw materials, such as metals, are also reused in the casting process, minimising waste.

In addition to waste management, we also strive to manage our emissions responsibly. Our facilities are inspected every two years by independent auditors who monitor our emission levels.

[Sand Recycling]

We recycle 100% of our sand and use chemically bonded sand systems which comply with current environmental regulations.

Sand Systems

- Chemically bonded
- Shell moulded

Sand Grades

- 80 AFS precision sand
- 100 AFS shell moulding



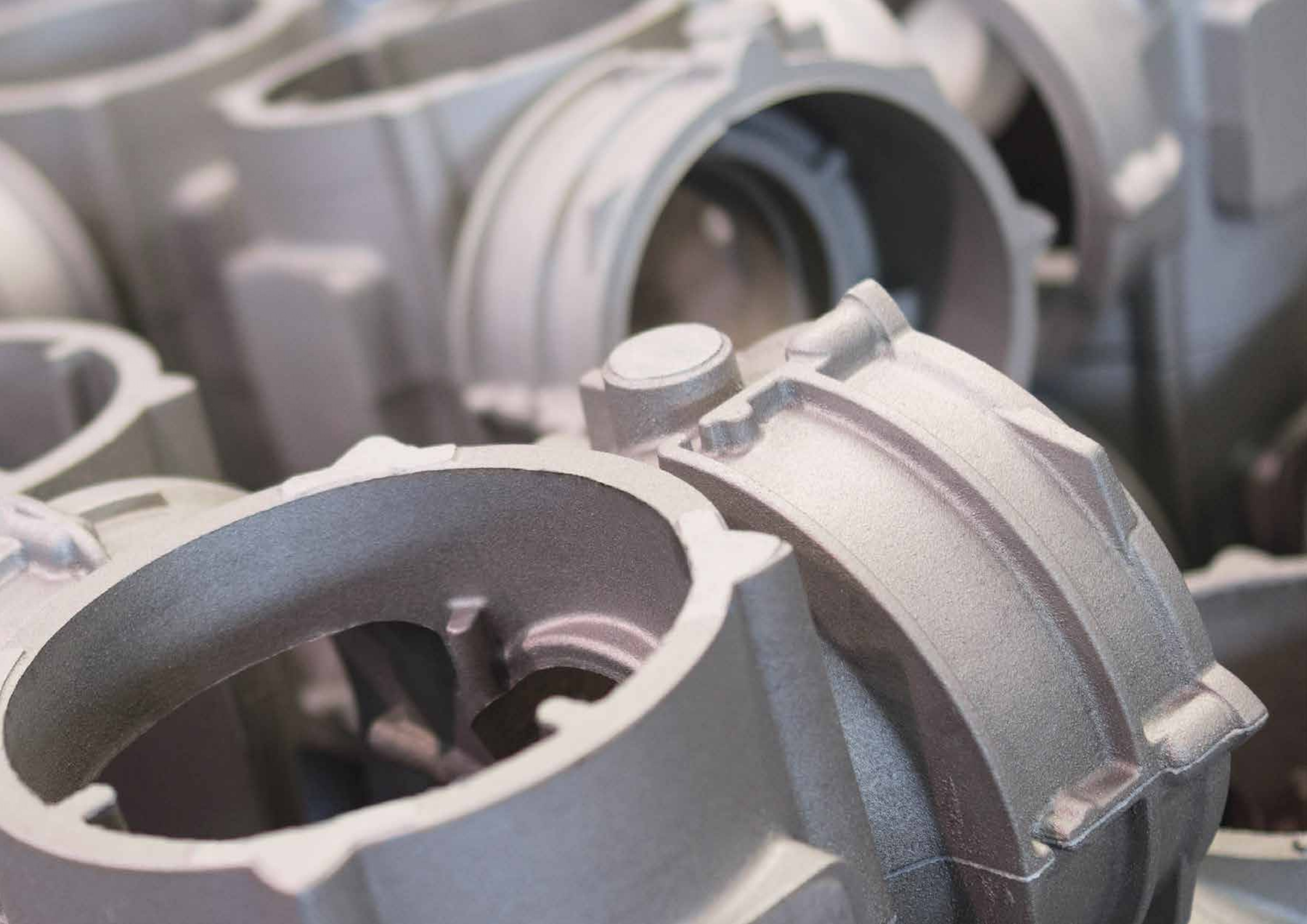





Contact details

For more information about Haworth Castings or to discuss your project requirements, please get in touch.

You can also visit our website at www.haworthcastings.co.uk

T +44 1794 512 685

F +44 1794 830 086

E sales@haworthcastings.co.uk

Haworth Castings Foundry

Budds Lane Industrial Estate
Romsey
Hampshire
SO51 0HA

Haworth Castings Machining Facility

Northgate
Hampshire International Business Park
Crockford Lane
Basingstoke
Hampshire
RG24 8WH

